

## NorDan NTech Villa Fixed Light Passive

Calculation of U-value in accordance to NS-EN ISO 10077-1, 10077-2 and the programme "Therm".  
Centre U-value of glass is calculated in accordance to NS-EN 673.  
Head Office: NorDan AS, Stasjonsveien 46. 4460 Moi, Norway. Web: [www.nordan.uk](http://www.nordan.uk)

### Report of standard model

Date: 11.06.2021

Version: TL/BL/FA 105 Passive

Type: Fixed Light

Model: NTech Villa/FA 105 Passive

Glass configuration: 4E+18G+4+18G+4E Planitherm Ultra N\*, TGI\*, Argon

### Main results and dimensions

U-value: 0,70 W/m<sup>2</sup>K

Width: 1230 mm

Height: 1480 mm

Area: 1,82 m<sup>2</sup>

Percent glass: 84,02%

g-value: 0,53

LT-value: 0,74

Ug-value: 0,53 W/m<sup>2</sup>K

The elements share of the total heat loss: 64,1%

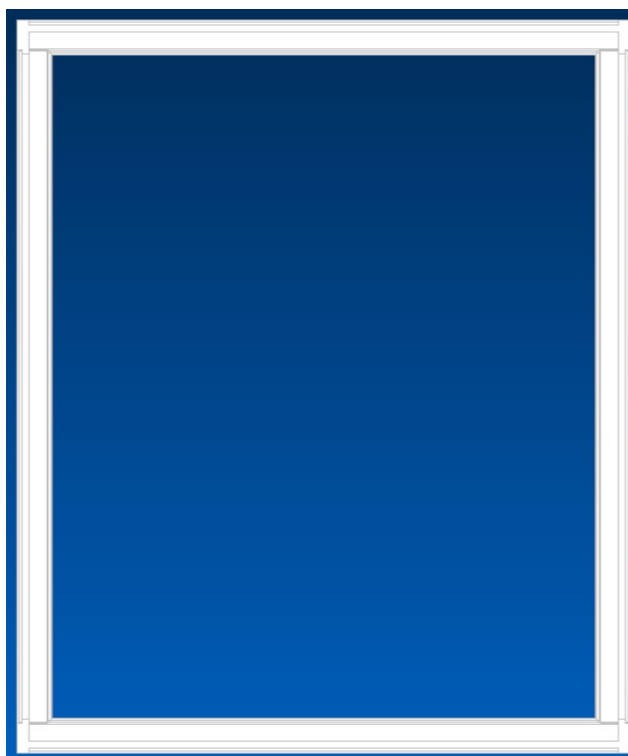

# U-værdi beregninger - NTech Villa fast karm passiv



Dokument ID: 00091F(3.00)

Dato: 11 Juni 2021

Side: 2 af 4

Produktegenskab: Passiv

Karm: 105

Glas: 3-glas

Gælder for produktkoder:  
BL, FA, TL

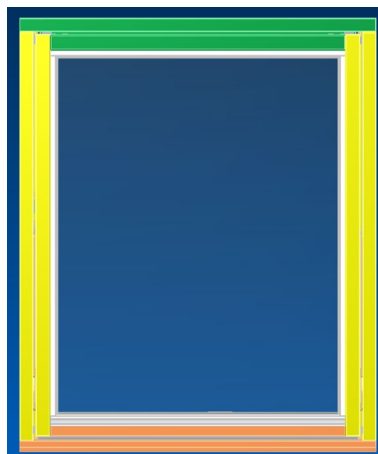

Colour	Uf (W/m <sup>2</sup> K)	Width (m)	Name
Yellow	0,859	0,056	Jamb profile
Green	0,859	0,056	Head profile
Orange	1,128	0,056	Sill profile

Color	Uf (W/m <sup>2</sup> K)	Element area (m <sup>2</sup> )	*Percent element (%)
Yellow	0,859	0,0797	4,38
Green	0,859	0,0657	3,61
Orange	1,128	0,0797	4,38
Yellow	0,859	0,0657	3,61
Sum		0,292	15,98

\*: Figure in relation to the whole window

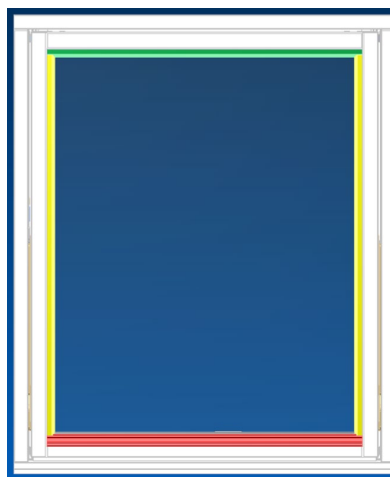

Colour	PSI	Length (m)	Name
Yellow	0,038	2,736	TGI Jamb
Green	0,038	1,118	TGI Head
Orange	0,038	1,118	TGI Sill

Color	Spacer length (m)	L Psi spacer (W/K)	*L Psi spacer (%)
Yellow	1,368	0,052	27,7
Green	1,118	0,042	22,3
Orange	1,118	0,042	22,3
Yellow	1,368	0,052	27,7
Sum	4,972	0,188	100,0

\*: Figure in relation to the spacer

## U-Value window frame (U<sub>f</sub>) Calculation according to EN ISO 10077-2

### Villa Fixed frame Head/Jamb

This example shows glass thickness 39 - 51mm:

$$U_t = 0,7358 \frac{W}{m^2K}$$



$$B_f = 56 \text{ mm}$$







$$U_f = \frac{L_f^{2D} - U_p * b_p}{b_f}$$

$$L_f^{2D} = U_t * L$$

$$L_f^{2D} = 0,7358 * (0,056 + 0,19) = 0,181 \text{ W/mK}$$

$$U_f = \frac{0,181 - (0,7 * 0,19)}{0,056} = 0,859 \text{ W/m}^2\text{K}$$

Boundary Conditions	Temp: °C	Hc: W/m <sup>2</sup> K
 Exterior	0	25
 Interior	20	7,69

Material:	λ(W/mK)	ρ
 Pine	0,12	0,9
 Aluminium	160	0,9
 Panel	0,035	0,9
 Gasket EPDM	0,25	0,9
 Gasket QL	0,03	0,9
 Frame cavity- Cen slightly ventilatet		
 Frame cavity-Cen Simplified		

U <sub>t</sub>	U <sub>p</sub>	L <sub>f</sub> <sup>2D</sup>	U <sub>f</sub>
Glass thickness 39-51 mm			
0,7358	0,7	0,181	0,859

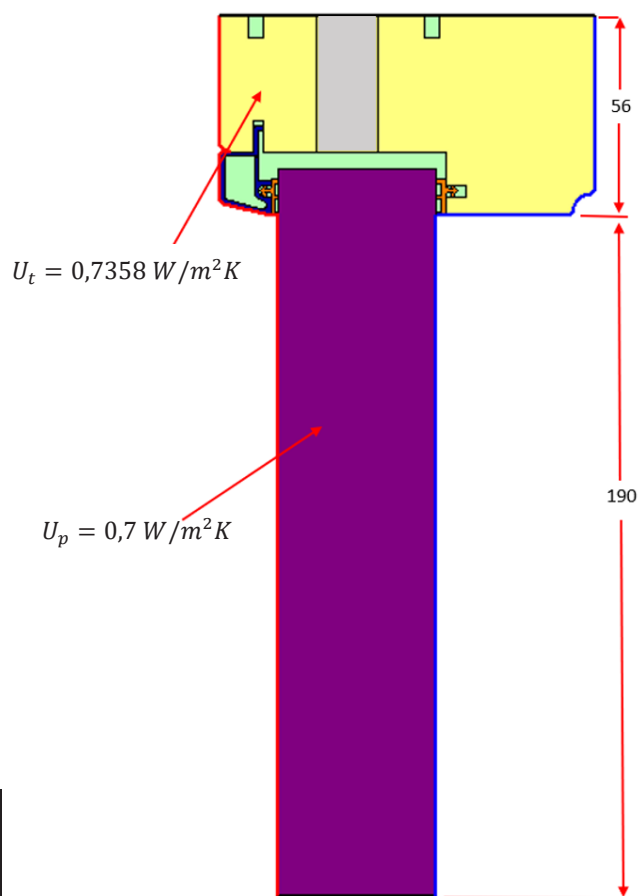

## Villa Fixed frame Sill

This example shows glass thickness 39 - 51mm:

$$U_t = 0,7967 \frac{W}{m^2K}$$

$$B_f = 56 \text{ mm}$$

$$U_f = \frac{L_f^{2D} - U_p * b_p}{b_f}$$

$$L_f^{2D} = U_t * L$$
  

$$L_f^{2D} = 0,7967 * (0,056 + 0,19) = 0,196 \text{ W/mK}$$
  

$$U_f = \frac{0,196 - (0,7 * 0,19)}{0,056} = 1,128 \text{ W/m}^2\text{K}$$

Boundary Conditions	Temp: °C	Hc: W/m²K
Exterior	0	25
Interior	20	7,69

Material:	λ(W/mK)	ρ
Pine	0,12	0,9
Aluminium	160	0,9
Panel	0,035	0,9
Gasket EPDM	0,25	0,9
Gasket QL	0,03	0,9
Frame cavity- Cen slightly ventilated		
Frame cavity-Cen Simplified		

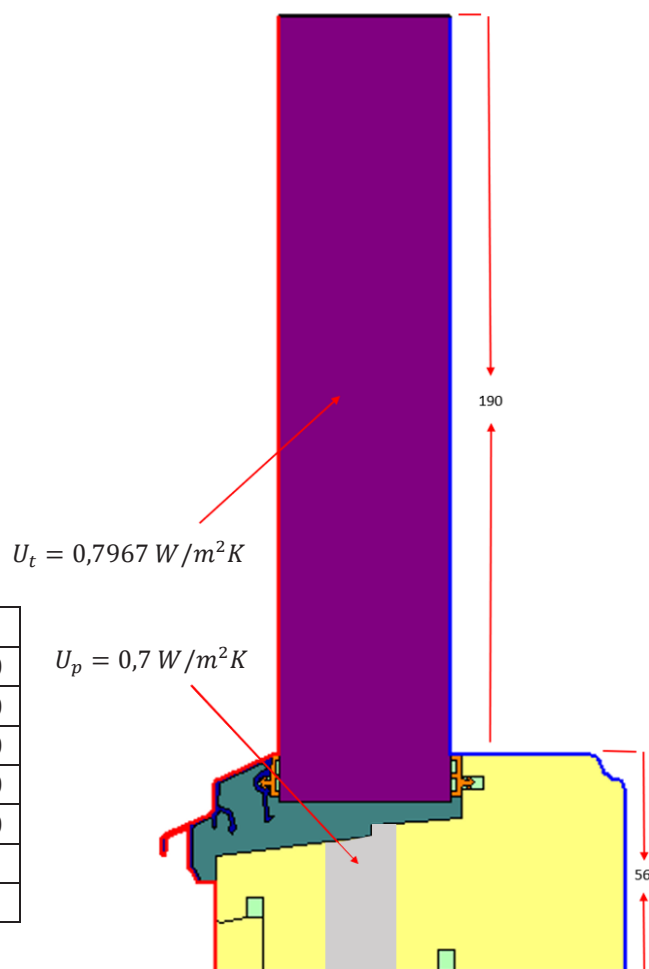

$U_t$	$U_p$	$L_f^{2D}$	$U_f$
Glass thickness 39-51 mm			
0,7967	0,7	0,196	1,128